

BROCHURE

# Manual Transfer Switching Equipment from 125 to 3200 A

**SIRCOVER**



When **energy** matters

**socomec**  
Innovative Power Solutions

# Why choose Socomec's *SIRCOVER*?

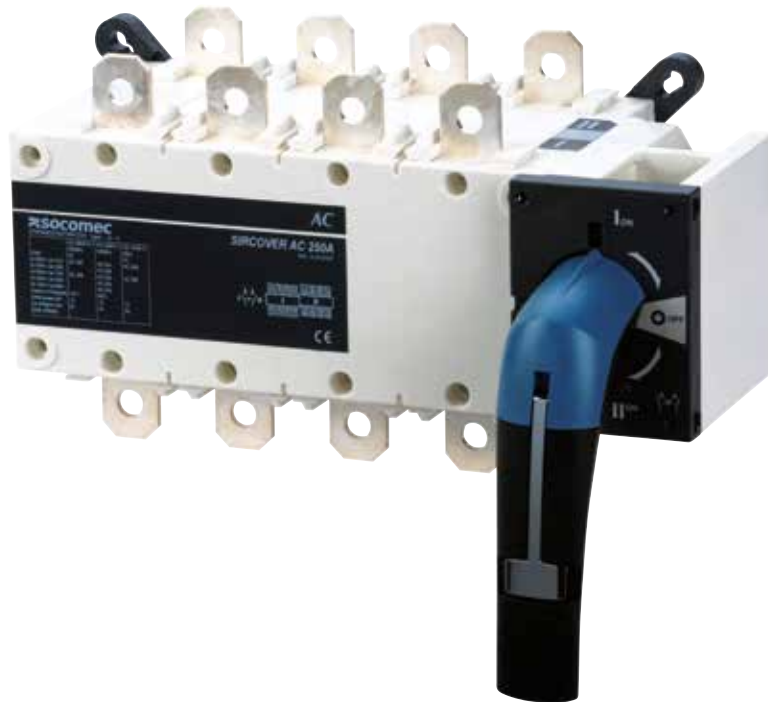

Constant power availability keeps your activity safe and efficient. At Socomec, we have been designing, manufacturing and testing switchgear since 1922 and guarantee safe, reliable and long lasting Transfer Switching Equipment (TSE) for your electrical installation. All our solutions are fully compliant with Class PC of IEC 60947-6-1, the international product standard for TSE.

Today, more than 3 million installations and major integrators worldwide are secured with a Socomec transfer switch. Each day, their smile is ON knowing that their operations will always keep on running.



## Safe operation

The ability to execute a manual transfer - even under load supply - at any time. Based on load break switching technology, the isolation function guarantees safe downstream maintenance operations.



## Reliability

Fully mechanical operation with no dependence on electronics. High MTBF to ensure maximum availability.



## Proven technology

Integrated solution that has been engineered and tested according to IEC 60947-6-1 Class PC standard requirements for transfer switching.



## Easy to use

Error-free thanks to the most reliable mechanically held contact technology. A simple design with clear position indication.



## Maintenance free

Virtually no maintenance required at any level. Just one operation per year is sufficient to ensure long term reliability.

# Why do you need Transfer Switching Equipment (TSE)?

Power outages can occur, even in high reliability distribution networks, leading to major incidents and losses on critical applications :

- Emergency systems.
- Healthcare facilities.
- Server rooms.
- Production lines.

To maximize your power availability, the Socomec range will safely transfer from any unstable or lost source to an alternate source. Furthermore, we ensure that you are prepared at all times thanks to our unique safety functions that facilitate maintenance on your low voltage electrical installation.

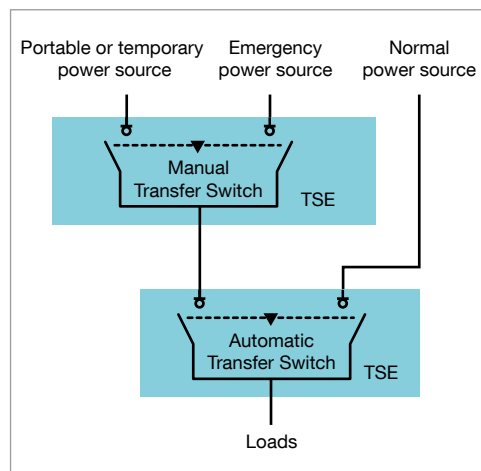

## Robust and cost effective power availability

Contact us to find out how your application could benefit from SIRCOVER.



### Emergency or portable power sources

An interrupted power supply to a production line can result in significant downtime and economic losses. Production continuity can be guaranteed by providing the installation with an alternate power source and a safe and reliable transfer system.

### External maintenance bypass

Convert your power electronic device - such as a UPS or speed drive - to a fully replaceable and maintainable system, thanks to the all-in-one SIRCOVER BYPASS switch. If you switch your UPS to static bypass you can even perform the bypass operation without a blackout by using the I-I+II-II version.



### Restore power when the utility fails with stand-by generating sets

Hit by a power-cut? Simply plug your generator into your installation and changeover with an easy to use manually operated transfer switch.

# Main features

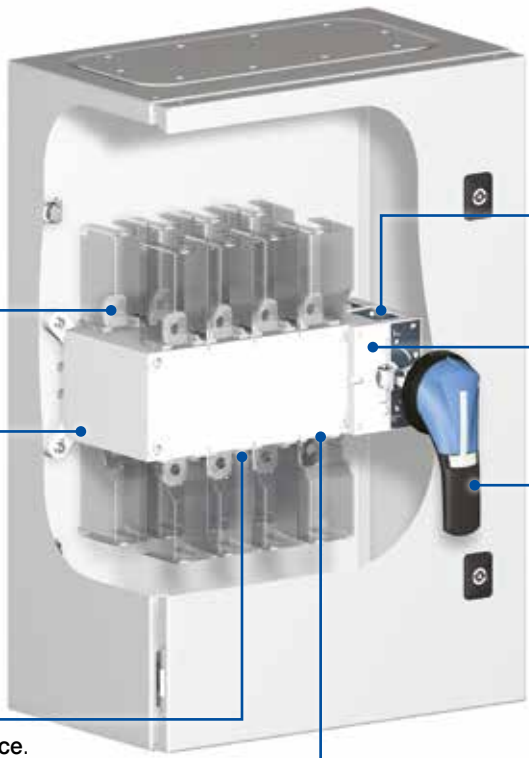

**Load break switch based**  
High Isc withstand.

**IEC 60947-3  
IEC 60947-6-1  
GB/T 14048.11  
Class PC &  
UL1008**  
Standards compliance.

**Safety functions:**

- Padlocking and isolation for **maintenance**.
- Inherent mechanical **interlock**.
- **3 stable** positions mechanically held.

**Upgradeable**  
Motorize your transfer switch by adding Socomec's ATyS modules.

**Compact design**  
back-to-back format.

**Multiple accessories and product versions** that adapt to your needs:

- I-O-II.
- Bypass.
- Overlapped.
- Enclosed.
- Integrate within a system.

**No maintenance needed**  
Self-cleaning contacts.

# Improve your redundancy with a Bypass solution



**Bypass an UPS**

- I-O-II version 125 – 1600 A.
- I-I+II-II version 125 – 1600 A.
- Integrated external bypass for UPS.

*SIRCOVER Bypass*

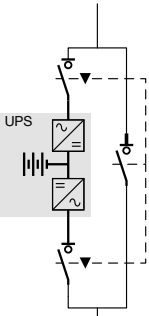







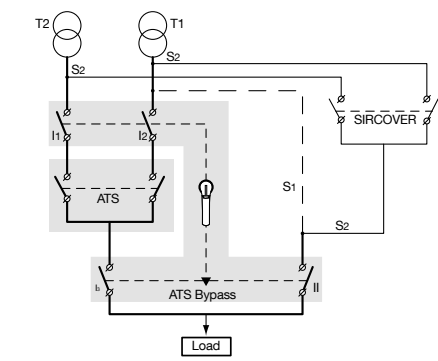

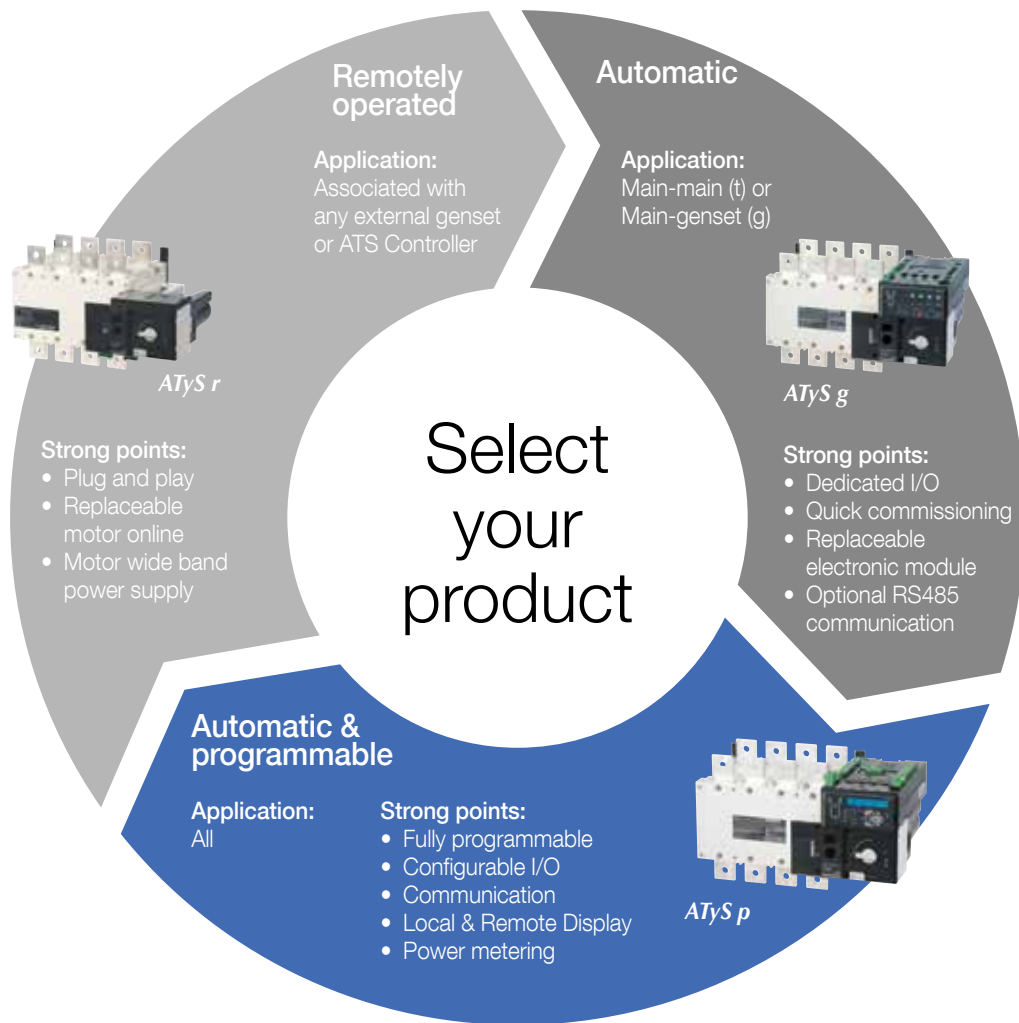

















**Bypass an ATS**

*SIRCOVER ATS Bypass*

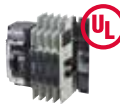



### A solution for every application

Manual	Remotely operated	Automatic	Enclosed
 <i>COMO CS</i>  <i>SIRCO M</i>	 <i>ATyS d M</i>	 <i>ATyS t M &amp; g M</i>  <i>ATyS p M</i>	 <i>ATyS M enclosed</i>  <i>ATyS Bypass</i>
 <i>SIRCOVER</i>  <i>SIRCOVER Bypass</i>	 <i>ATyS r</i>  <i>ATyS d H</i>	 <i>ATyS g</i>  <i>ATyS p</i>	 <i>ATyS enclosed</i>  <i>ATyS Bypass</i>
 <i>SIRCOVER UL</i>	 <i>ATyS UL</i>  <i>ATyS FT &amp; DT</i>	 <i>ATyS FT &amp; DT</i>	
ATS controller			Static switch
 <i>ATyS C55</i>	 <i>ATyS C65</i>	 <i>ATyS C66</i>	 <i>STATYS</i>

# Socomec: our innovations supporting your energy performance

**1** independent manufacturer

**4,200** employees  
worldwide

**8** % of sales revenue  
dedicated to R&D

**400** experts  
dedicated to service provision

## Your power management expert



POWER  
SWITCHING



POWER  
MONITORING



POWER  
CONVERSION



ENERGY  
STORAGE



EXPERT  
SERVICES

## The specialist for critical applications

- Control, command of LV facilities
- Safety of persons and assets
- Measurement of electrical parameters
- Energy management
- Energy quality
- Energy availability
- Energy storage
- Prevention and repairs
- Measurement and analysis
- Optimisation
- Consultancy, commissioning and training

## A worldwide presence

**12** production sites

- France (x3)
- Italy (x2)
- Tunisia
- India
- China (x2)
- USA (x2)
- Canada

**30** subsidiaries and commercial locations

- Algeria • Australia • Austria • Belgium • China • Canada
- Dubai (United Arab Emirates) • France • Germany
- India • Indonesia • Italy • Ivory Coast • Malaysia
- Netherlands • Poland • Portugal • Romania • Serbia
- Singapore • Slovenia • South Africa • Spain • Sweden
- Switzerland • Thailand • Tunisia • Turkey • UK • USA

**80** countries

where our brand is distributed

### HEAD OFFICE

#### SOCOMECC GROUP

SAS SOCOMECC capital 10 568 020 €  
R.C.S. Strasbourg B 548 500 149  
B.P. 60010 - 1, rue de Westhouse  
F-67235 Benfeld Cedex  
Tel. +33 3 88 57 41 41 - Fax +33 3 88 57 78 78  
info.scp.isd@socomecc.com

### YOUR DISTRIBUTOR / PARTNER

[www.socomecc.com](http://www.socomecc.com)



**100** years  
OF SHARED ENERGY

**socomecc**  
Innovative Power Solutions